

DE: Mantarochen

EN: manta ray

AT: Manta

design: jacques kohler 2014



Die Gattung der Mantarochen (*Manta*) gehört in der Familie der Adlerrochen (*Myliobatidae*) zur Unterfamilie der Teufelsrochen (*Mobulinae*). Sie kommt weltweit in tropischen und subtropischen Meeren in Küstennähe bis zu einer Tiefe von 150 Metern vor. Die Tiere können fünf bis neun Meter lang und drei Tonnen schwer werden.

Quelle <http://de.wikipedia.org>

Manta rays are large eagle rays belonging to the genus *Manta*. They are classified among the Elasmobranchii (sharks and rays) and are placed in the eagle ray family *Myliobatidae*. Mantas can be found in temperate, subtropical and tropical waters.

Source <http://en.wikipedia.org>

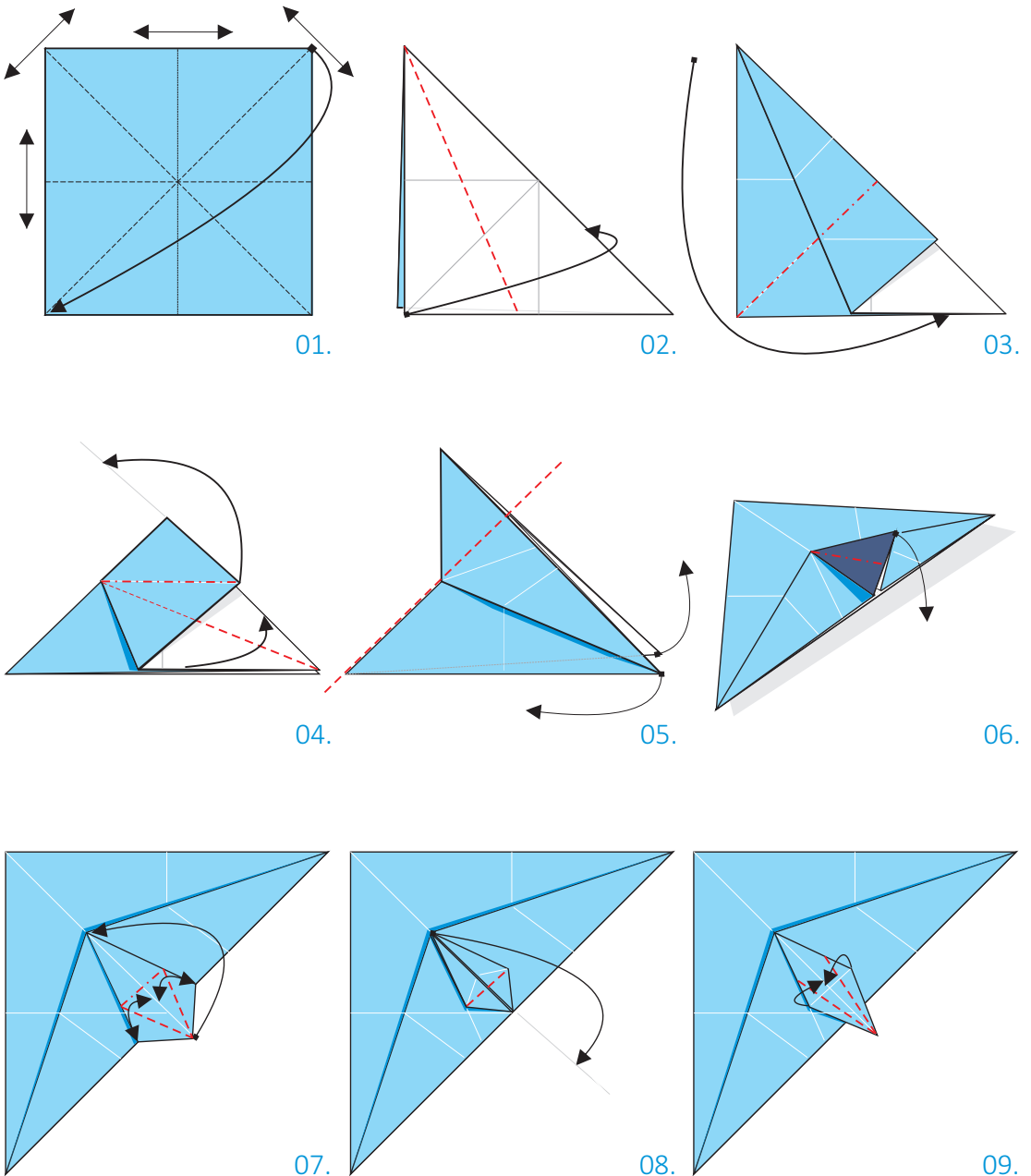

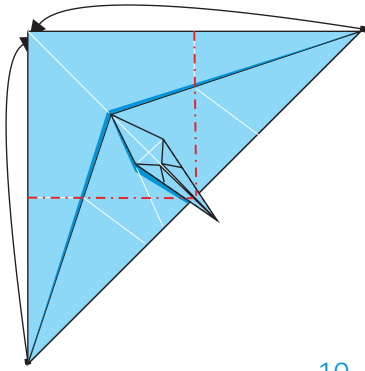

10.

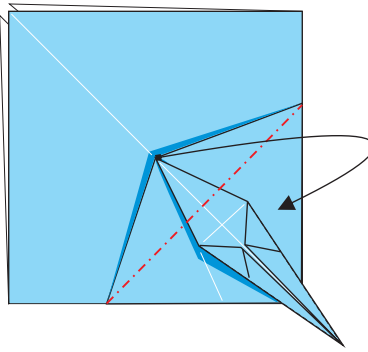

11.

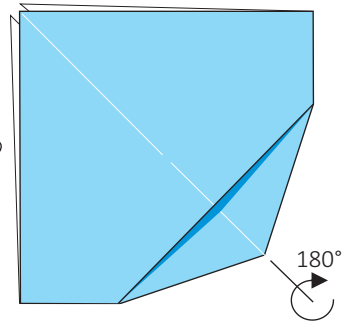

12.

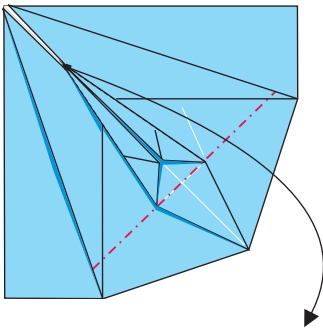

13.

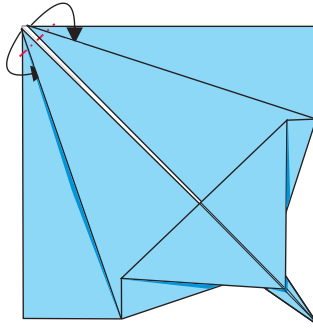

14.

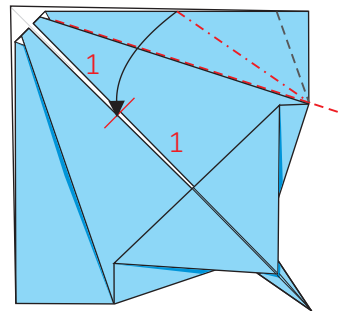

15.

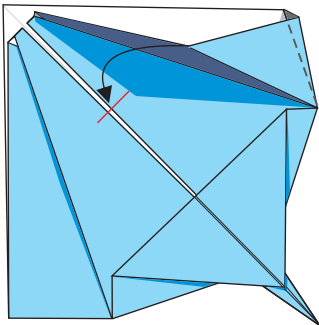

16.

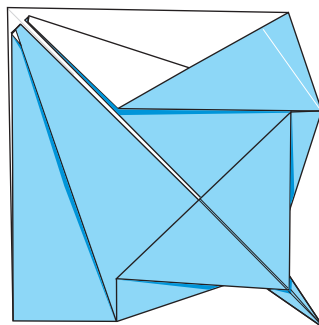

17.

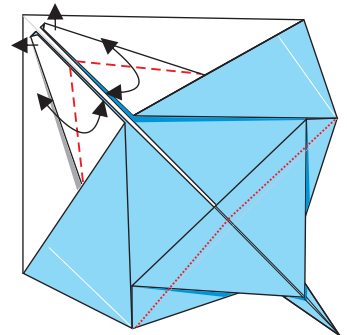

18.

15-17 selbe Faltungen
auf der linken Seite
15-17 same procedure
on left side

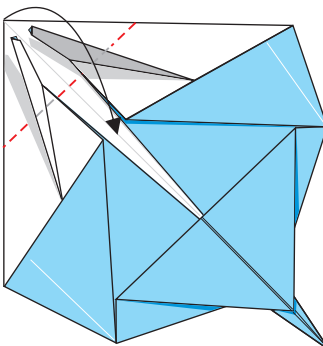

19.

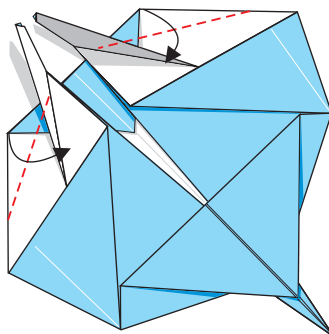

20.

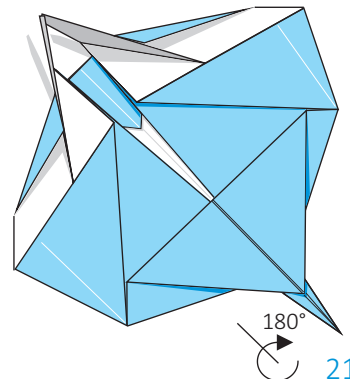

21.

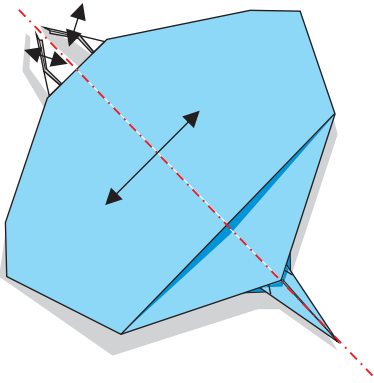

20.

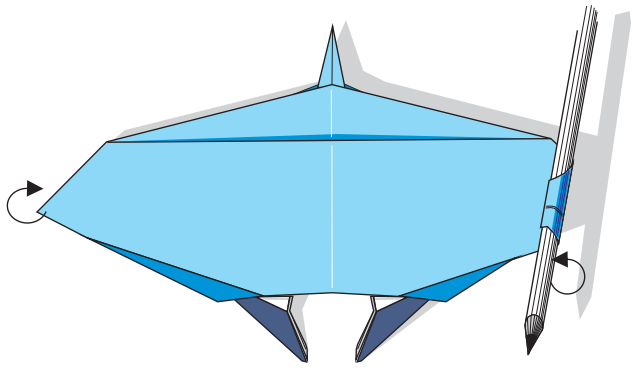

21.

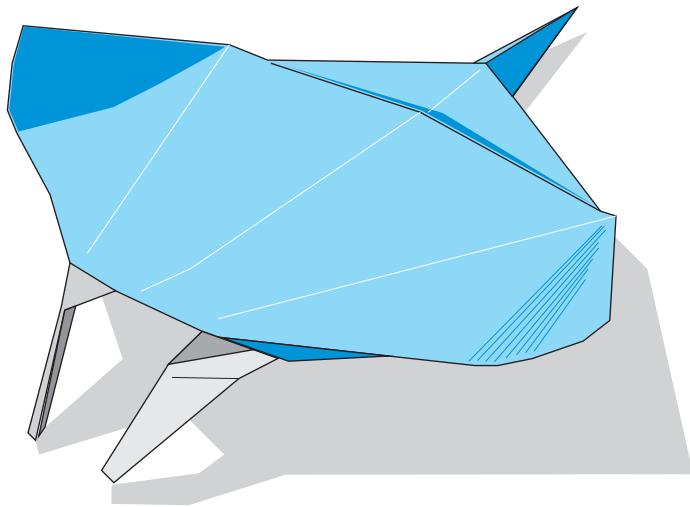

22.